

Tableau pour clés „Famille“



OUTILLAGE CONSEILLÉ :



crayon & règle

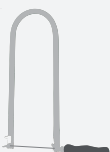

ciseaux

ruban
adhésifscie à
chantournerpapier
abrasif

coll à bois / universelle

forêt
Ø 3 mm

NOM :

CLASSE :

LISTE DES PIÈCES :

DIMENSIONS :

PIÈCES :

1 contreplaqué

OK✓



200 x 115 x 4 mm

A

1 latte de pin



200 x 50 x 10 mm

B

1 ficelle en coton



880 mm

E

4 boules en bois



Ø 25 mm, trou 6 mm

C

4 perles en bois



Ø 8 mm, trou 2 mm

D

1 Vue d'ensemble :

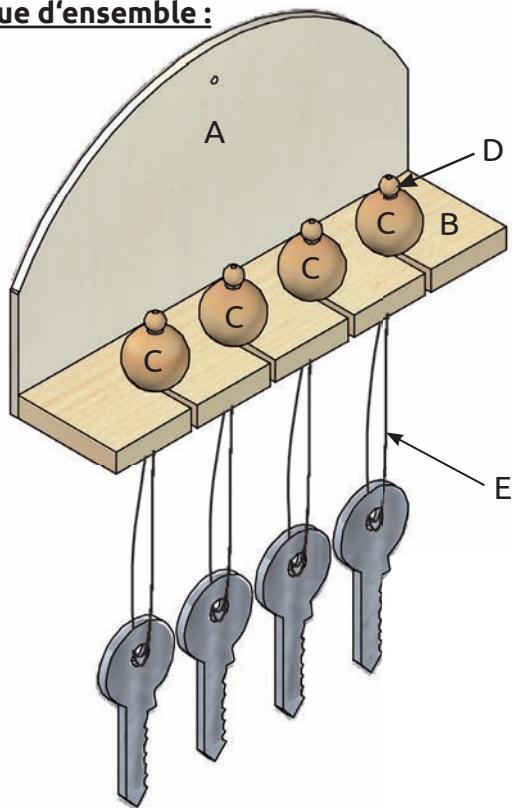

Jette un coup d'oeil sur **l'ensemble**.



2 Pièce (A) :

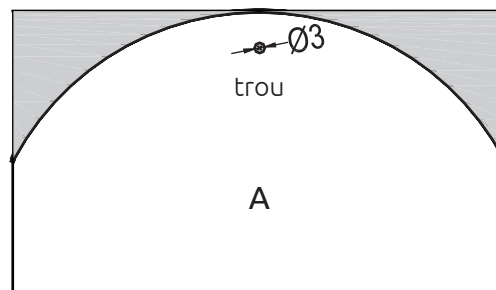

Avec les ciseaux, découpe grossièrement le **gabarit** de la pièce (A) et fixe-le avec du ruban transparent sur le contreplaqué.

Perce le **trou Ø 3 mm**.

Découpe la pièce (A) avec la **scie à chantourner**.

Travaille tous les bords et surfaces avec le papier abrasif.



3 Pièce (B) :

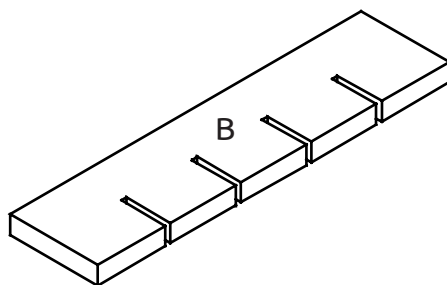
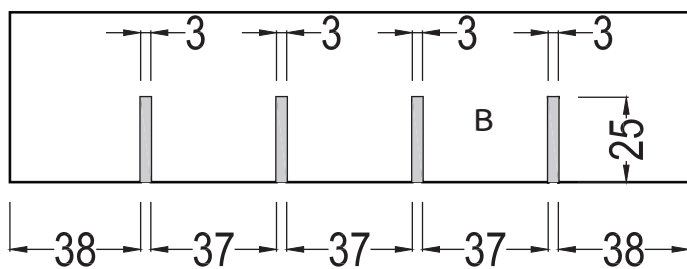
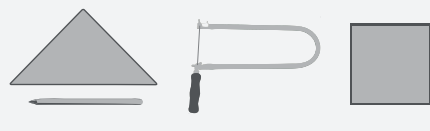

Reporte les **mesures** selon le schéma sur la latte en pin (B).

Découpe les **encoches** avec la scie à chantourner.

Travaille la pièce (B) avec le **papier abrasif**.



4 Assemblage pièces (A, B) :

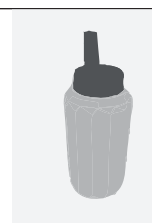
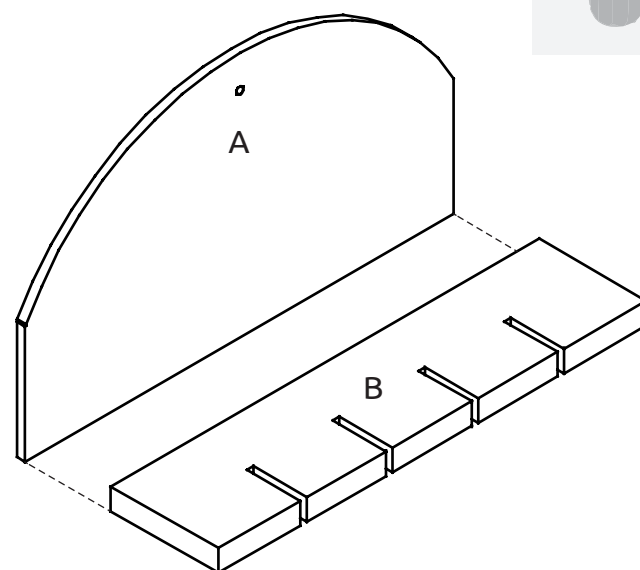

Colle la latte (B) sur le contreplaqué (A).



5 Finition et décoration :

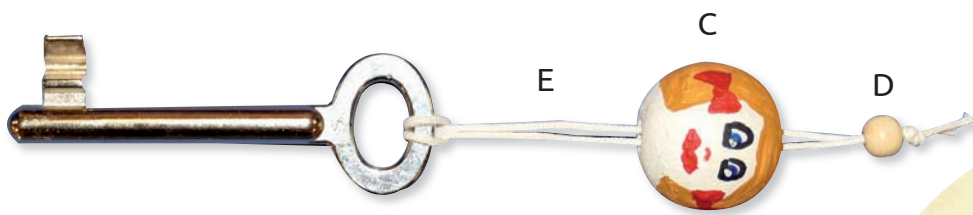

Découpe 4 longueurs d'env. 200 mm de la **ficelle en coton**.

Enfile sur la ficelle (E) les boules en bois (C), les perles en bois (D) et une clé selon le schéma et fais un noeud au-dessus de la perle en bois (D).

Décore et peins ton tableau pour clés selon tes goûts et idées.



BON AMUSEMENT ET BONNE RÉUSSITE !

OK✓

